

Split Systems

Heating and
cooling solutions



Perfecting the Air

Every day we breathe in 10,000 litres of air. It nourishes us. Enriches us. A deep breath of clean air is exactly what nature intended. It's amazing that something we can't see can make such a difference to our health and well-being – and it's why we believe every breath should be 'perfect'.

At Daikin, we've been 'perfecting the air' for over 50 years to make your home a calm and comfortable place – for you and your family.

As 'Air Specialists', Daikin is driven to improve all aspects of indoor air quality - from temperature and humidity, to flow and cleanliness.



Contents

Indoor Air Quality and Health	4
Market-leading Streamer Technology	5
Comfort Reinvented	6
Zoned Energy Rating Label	8
Product Overview	10
Zena	12
Alira X	14
Cora	16
XL Premium	18
XL	19
Floor Standing	20
Mobile Controller	22
Why Choose a Daikin Specialist Dealer?	24
Product Specifications	25
Features Checklist	33

Indoor Air Quality and Health

Did you know that Australians spend around 90% of their time indoors? While we're all very aware of what affects outdoor air quality, we don't often consider what our indoor air quality is like and how it could impact the health of our family.

The air inside any home contains a range of pollutants and allergens that can contribute to poor indoor air quality, leading to potentially serious health problems for occupants.

At Daikin, we're dedicated to delivering products and technologies that not only create a comfortable living environment, but also a healthy environment. A range of our products features innovative technology that is designed to greatly reduce the presence of contaminants in the home so you can rest easy knowing your indoor air quality is at an optimum level.

Common household pollutants

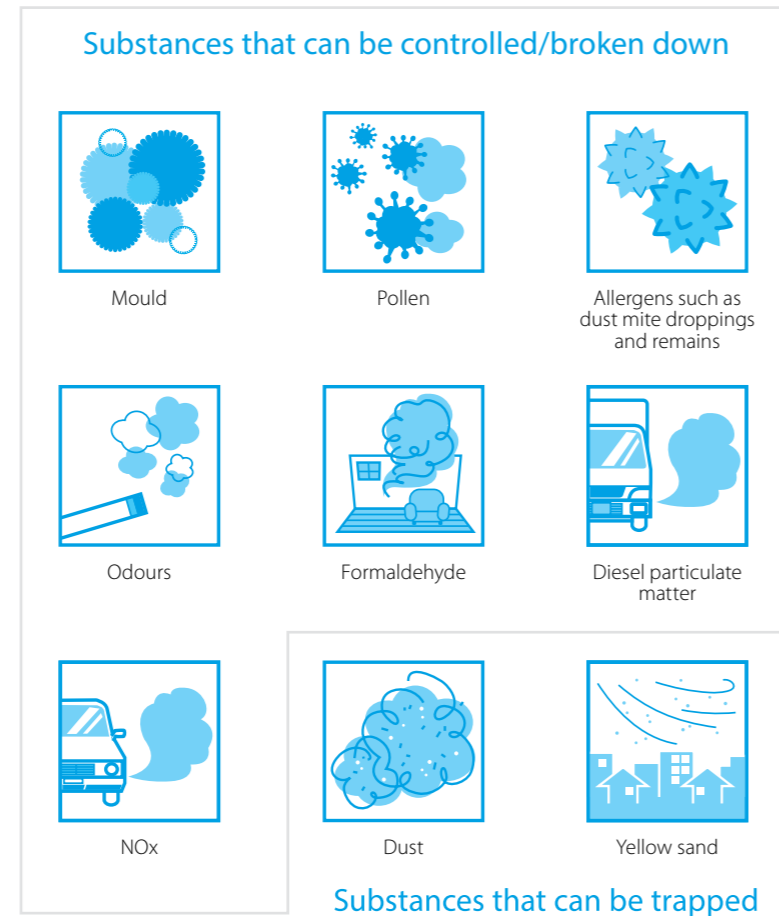

Market-leading Streamer Technology

The secret to high performance air purification is Daikin's Streamer Technology. This innovative technology, available in Daikin Air Purifiers and select Daikin Split System models, features a high-power plasma discharge that generates high-speed electrons to decompose harmful substances. This powerful oxidative decomposition process continuously removes odours, bacteria and indoor air pollutants such as formaldehyde for superior air purification.

Compared to standard plasma discharge, the speed of oxidative decomposition is over 1000 times greater with the same electrical power!

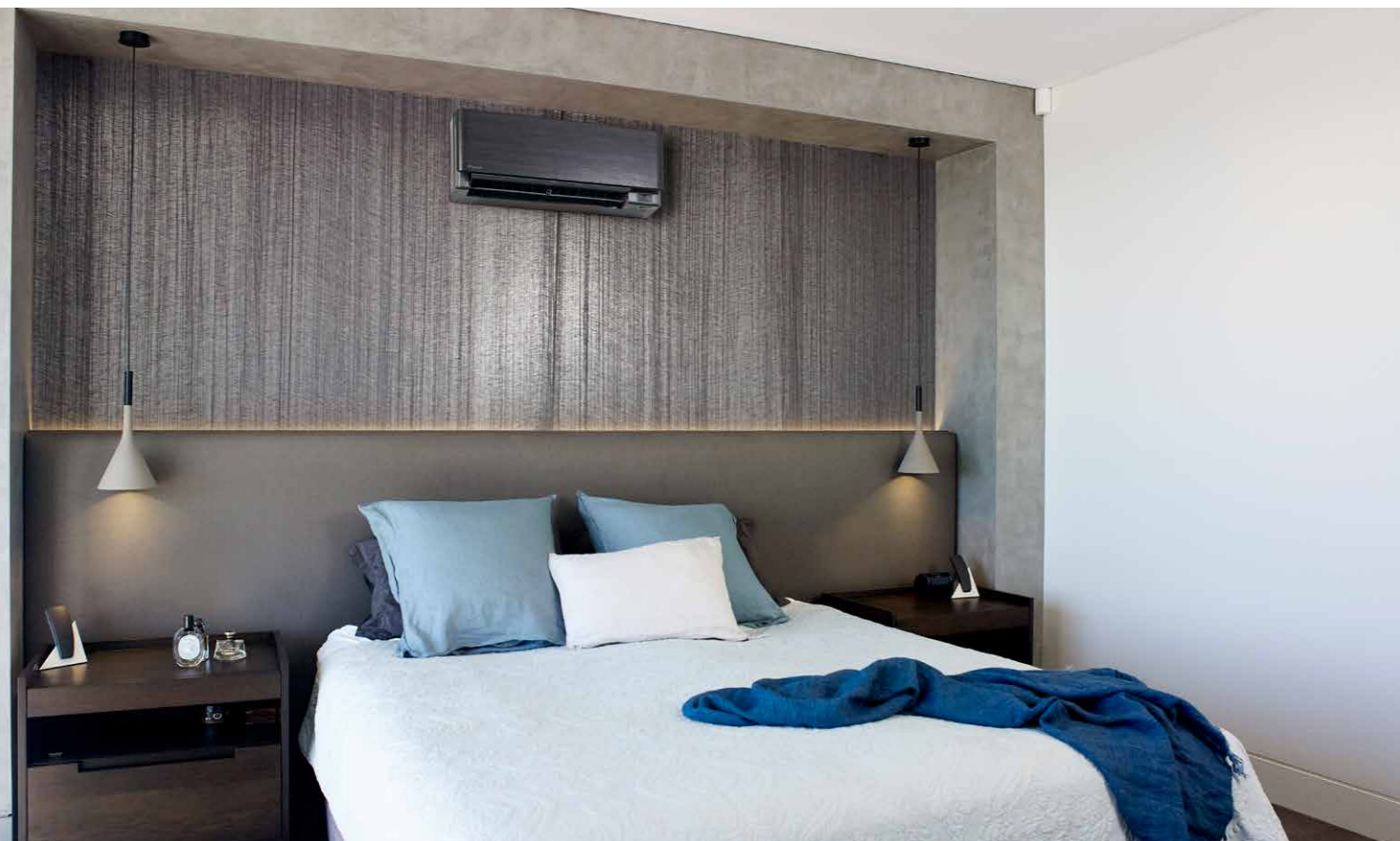

Streamer emits high-speed electrons.

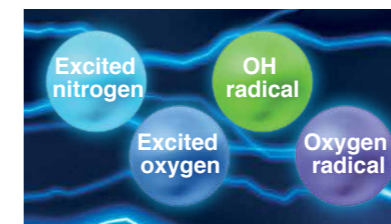

The electrons collide and combine with nitrogen and oxygen in the air to form four kinds of elements with powerful oxidative decomposition capabilities.

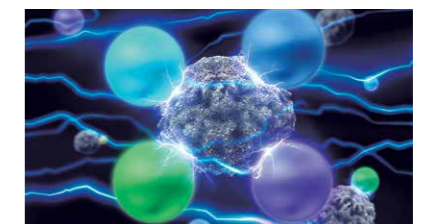

These elements break down unwanted substances.

How effective is Daikin Streamer Technology?



More than 99.6%¹ in 2 hours



More than 99.9%² in 24 hours



More than 99.61%¹ in 24 hours

¹ Verified at Wakayama Medical University with the following test condition: Irradiated allergens with Streamer & checked decomposition of allergen proteins by either the ELISA method, electrophoresis or electron microscopy.

² Verified at Japan Food Research Laboratories using antibacterial test/mould elimination test (test number: 204041635-001).

Comfort Reinvented

For over 90 years, Daikin has invested heavily in Research and Development to deliver more effective climate control for you and your family. Daikin technologies help make Daikin air conditioners energy efficient, powerful, reliable and easy to use.

Here are some examples of the innovative technology you can find in your Daikin split system.

GLOBAL WARMING POTENTIAL

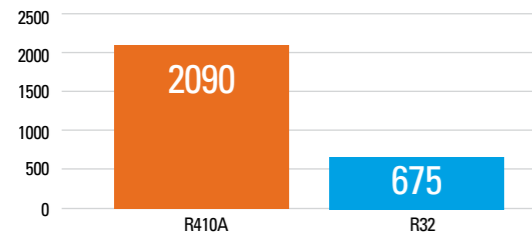

R32 refrigerant

All Daikin wall mounted split systems use R32 refrigerant. With a lower global warming potential and a higher refrigeration potential than refrigerants such as R410A, R32 systems can deliver more efficient cooling and heating with less risk of harm to the environment.

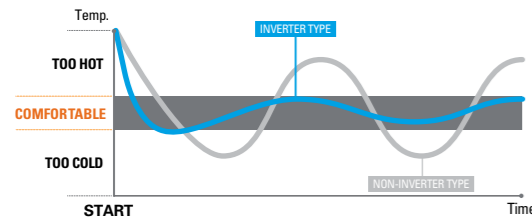

Inverter technology

An inverter system works like the accelerator of a car, gently increasing or decreasing power - helping reach the desired temperature more quickly, and steadily maintain it without fluctuations. That means uninterrupted comfort and significant savings on running costs.



Neodymium Magnet 10x Stronger

Ferrite Magnet

Reluctance DC motor

Our outdoor units incorporate Daikin's Reluctance DC motors. These motors which drive our compressors, use the magnetic torque of neodymium magnets in conjunction with reluctance torque, which can boost efficiency by up to 40% more than conventional motors.

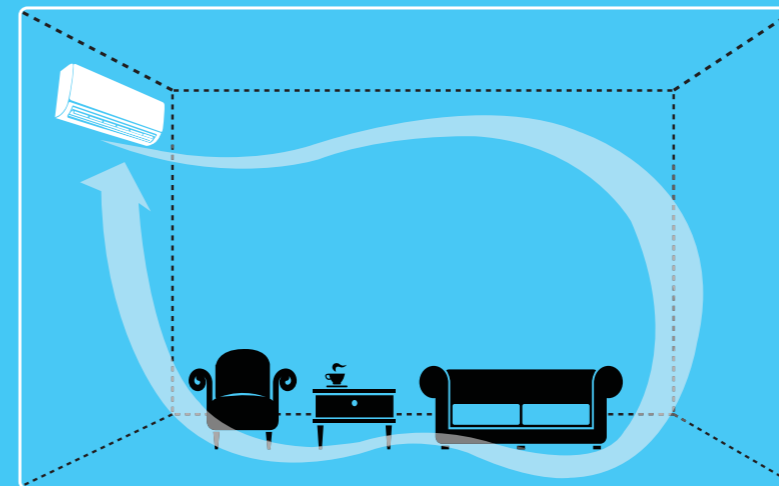

COANDA AIRFLOW TECHNOLOGY

Our wall mounted indoor units* feature an advanced louvre design for streaming air upwards along the ceiling and creating a circulatory air motion in the occupied space. This ensures rapid cooling of the area, even temperature distribution and improved comfort levels.

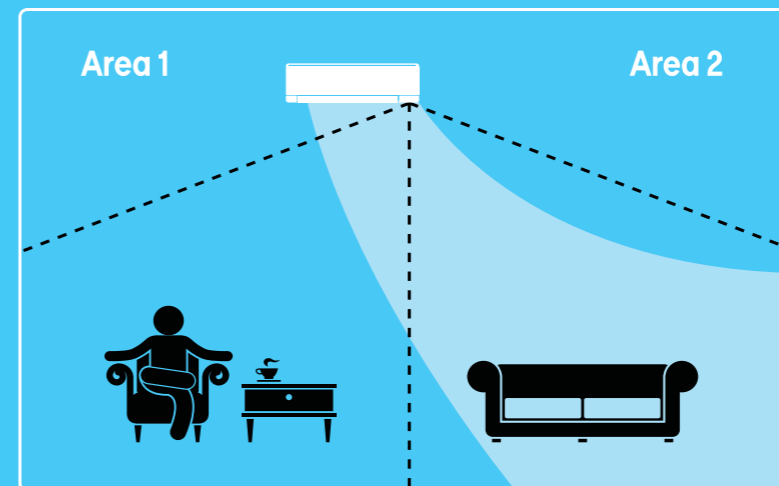

INTELLIGENT EYE SENSOR

Each indoor wall mounted model is fitted with Daikin's trademark Intelligent Eye human sensor. This sensor cleverly switches the unit into energy saving mode when the room is unoccupied. On models fitted with the more advanced 2-Area variant, the intelligent eye can also be used to provide draught free comfort.

Draught free comfort operations: If occupant detected in area 1, airflow is directed away

*Only applicable to Alira X & Cora 20-71 Class Models, and all Zena Models



Zoned Energy Rating Label

In simple terms, the Zoned Energy Rating Label (ZERL) enables you to compare the performance of different air conditioners in a number of ways. These include capacity output, energy efficiency as well as sound levels.

To understand the energy efficiency of a product, the star rating system explains this simply with more stars signifying a more efficient product up to a maximum of ten possible stars.

With Australia's considerable geographic and climatic diversity, the same product installed in Darwin will perform differently further south in Sydney or Melbourne.

As a result, the rating system divides the continent into three distinct climate zones (hot, average, and cold), which allows you to easily identify and compare air conditioners within the climatic zone you live in. The more stars, the more efficient the air conditioner will be.

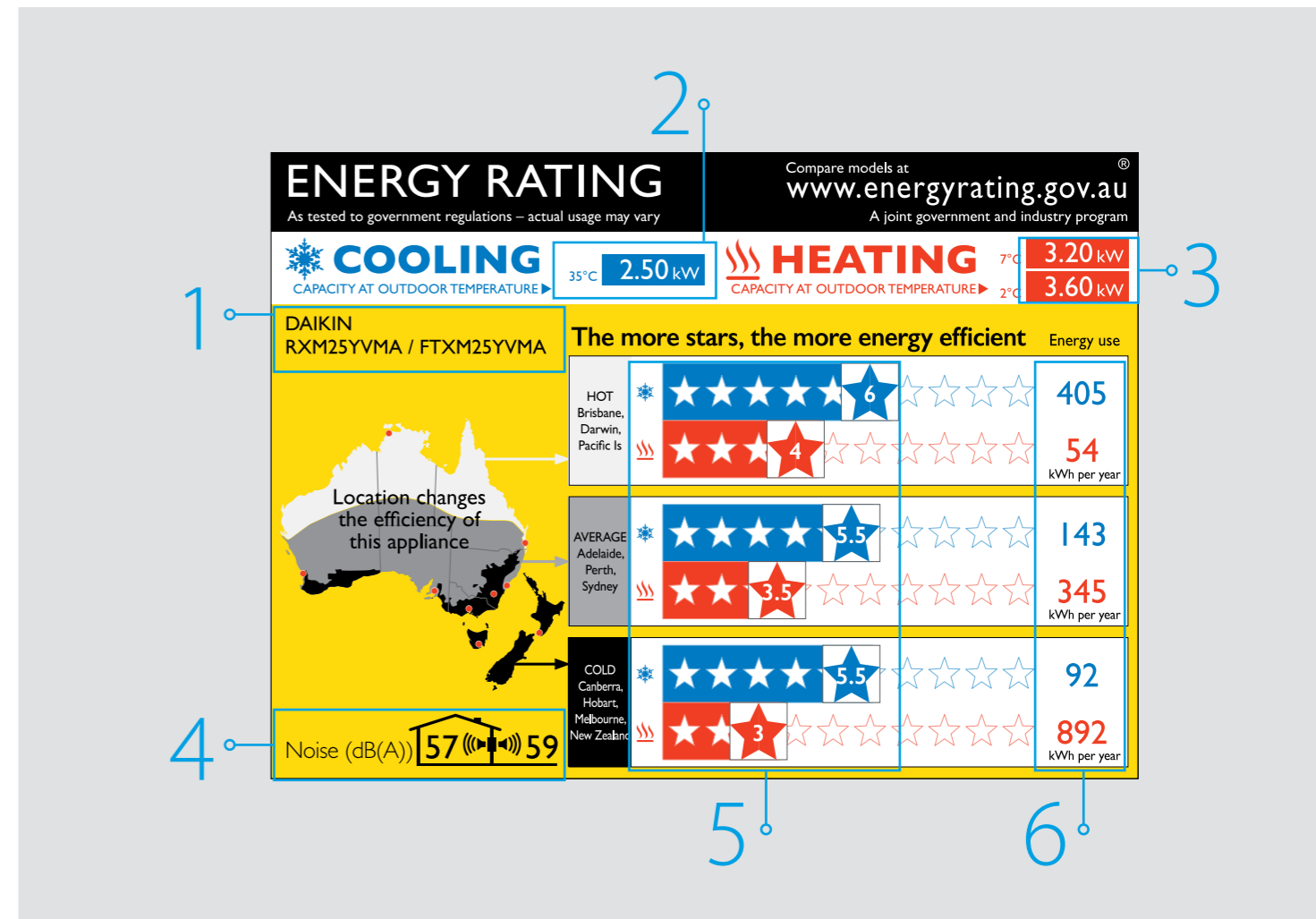

How to read the label

- Brand & model**
This is the brand and model number of the air conditioner. Use this to ensure you are looking at the right information for your desired model.
- Cooling capacity**
This is the available cooling capacity (kW) of the air conditioner when at an indoor temperature of 27°C & outdoor temperature of 35°C (T1)*.
- Heating capacity**
This is the available heating capacity (kW) of the air conditioner when at an indoor temperature of 20°C & outdoor temperature of 7°C (H1) or 2°C (H2)*.
- Sound levels**
The values indicate the sound power level[^] of the indoor unit and the outdoor unit. Lower numbers reflect quieter operation.
- Star ratings**
The stars show you how efficient the air conditioner will perform in each of the three climate zones. The more stars, the more efficient.
- Energy usage**
This tells you the energy usage of the air conditioner per year for cooling & heating. The lower the kWh used, the lower the running cost (multiply by your electricity tariff for estimated running cost).

*The capacity is determined under conditions T1 (cooling), H1 & H2 (heating) of AS/NZS 3823.1.1

[^]Measured under conditions T1 (cooling) of AS/NZS 3823.1.1

Product Overview

Zena

2.5kW to 6.0kW (8 models)

Stylish designer model engineered with the latest technology and built-in Wi-Fi capability. Available in White Hair Line or Black Wood finish.

Key features

- › Ultra Compact Design
- › Streamer Technology
- › Intelligent Eye
- › Grid Eye Sensor
- › Vertical Airflow
- › Built-in Wi-Fi



STAR RATING	CLASS	25	35	50	60
ZERL (Residential) Hot/Avg/Cold	COOL	4/3.5/3.5 ★	3.5/3.5/3.5 ★	3.5/3/3.5 ★	2.5/2.5/2.5 ★
	HEAT	3/3/2.5 ★	3/2.5/2 ★	3/2.5/2 ★	3/2.5/2 ★

Alira X

2.2kW to 7.1kW (7 models)

Alira X is a step ahead of the rest, delivering a perfect fusion of whisper quiet comfort, industry leading energy efficiency and indoor air quality technology.

Key features

- › 2-Area Intelligent Eye (20-46 Class only)
- › Intelligent Eye (50-71 Class only)
- › Enzyme Blue Deodorising Air Purification Filter
- › Streamer Technology
- › Mould Proof Operation
- › Built-in Wi-Fi



STAR RATING	CLASS	20	25	35	46	50	60	71
ZERL (Residential) Hot/Avg/Cold	COOL	6/5/5 ★	6/5.5/5.5 ★	5/4.5/5 ★	4.5/4/4 ★	5/4.5/5 ★	4.5/4.5/4.5 ★	3.5/3/3 ★
	HEAT	3.5/3.5/3 ★	4/3.5/3 ★	3.5/3.5/3 ★	4/3.5/3 ★	4/3.5/3 ★	4/3/2.5 ★	3.5/3/2.5 ★

Cora

2.0kW to 7.1kW (7 models)

Delivered in understated confidence, the Cora series comes fully featured with whisper quiet operation and without compromise on style.

Key features

- › 2-Area Intelligent Eye (20-46 Class only)
- › Intelligent Eye (50-71 Class only)
- › Enzyme Blue Deodorising Air Purification Filter
- › Coanda Airflow
- › Compact Form Factor



STAR RATING	CLASS	20	25	35	46	50	60	71
ZERL (Residential) Hot/Avg/Cold	COOL	5/4.5/4.5 ★	6/5/5.5 ★	5/4.5/4.5 ★	4/3.5/4 ★	5/4.5/5 ★	4/4/4 ★	3.5/3/3 ★
	HEAT	3/3/2.5 ★	3.5/3/3 ★	3/2.5/2.5 ★	3/2.5/2.5 ★	3.5/3/2.5 ★	3.5/3/2.5 ★	3/2.5/2 ★

XL Premium

8.5kW to 9.5kW (2 models)

Powerful performance and premium features meet sophisticated design to deliver ultimate comfort for open plan living.

Key features

- › Intelligent Eye
- › Enzyme Blue Deodorising Air Purification Filter
- › Streamer Technology
- › Built-in Wi-Fi
- › Mould Proof Operation



STAR RATING	CLASS	85	95
ZERL (Residential) Hot/Avg/Cold	COOL	3.5/3.0/3.5 ★	3.5/3.0/3.0 ★
	HEAT	2.5/2.0/2.0 ★	2.5/2.0/1.5 ★

Note: Reverse Cycle results shown

XL

8.0kW to 9.0kW (2 models)

Combining high capacity performance with a sleek design to ensure comfort in open plan living environments.

Key features

- › Intelligent Eye
- › Enzyme Blue Deodorising Air Purification Filter
- › Mould Proof Operation



STAR RATING	CLASS	80	90
ZERL (Residential) Hot/Avg/Cold	COOL	3.5/3.0/3.5 ★	3.0/3.0/3.0 ★
	HEAT	2.5/2.0/1.5 ★	2.5/2.0/1.5 ★

Floor Standing

2.5kW to 7.1kW (6 models)

Compact floor standing unit, ideal for colder climates and placement under a window sill or semi-recessed in an unused fireplace.

Key features

- › Dual Discharge Vents
- › Hot Start
- › Titanium Apatite Deodorising Air Purification Filter
- › Wide Operation range (as low as -15°C)
- › Quiet Turbo Fan



STAR RATING	CLASS	25	35	45	50	60	71
ZERL (Residential) Hot/Avg/Cold	COOL	3.5/3/3 ★	3.5/3/3 ★	2.5/2.5/2.5 ★	3.5/3.5/3.5 ★	3/2.5/3 ★	3/2.5/3 ★
	HEAT	3.5/3/2.5 ★	3/2.5/2 ★	3/2.5/2 ★	3.5/2.5/2 ★	2.5/2/1.5 ★	2/2/1.5 ★

LEGEND

Uses R32 refrigerant which has a lower 'Global Warming Potential' Factor than R410A

Approved by the Sensitive Choice® program from the National Asthma Council Australia

Optional Wi-Fi available

Built-in Wi-Fi

Built-in Streamer Technology for air purification

ERL Refers to 'Energy Rating Label' star rating as outlined in the GEMS 2013 Determination

ZERL (Residential) Refers to 'Zoned Energy Rating Label' residential star rating as outlined in the GEMS 2019 Determination

Engineered with the latest technology, its stylish and elegant design integrates seamlessly into the modern home. Available in White Hair Line or Black Wood finish.



2.5kW
-TO-
6.0kW
CAPACITY RANGE

8
MODELS

Zena

Designed to impress

- R32 refrigerant**
R32 is the next generation in refrigerants with 66% lower 'Global Warming Potential Factor' than R410A, providing less risk of harm to the environment.
- Built-in Wi-Fi**
The Wireless LAN module for connection to Daikin's Mobile Controller smartphone interface is now conveniently included inside the casing of the indoor unit.
- Vertical airflow**
During heating operation, the discharge louvres stream airflow down the wall and towards the floor for improved temperature distribution and comfort.

- Ultra compact design**
The new Zena not only exudes elegance in design, it is packaged in an ultra compact discreet casing size of only 295mm high, 798mm wide and 185mm deep.
- Coanda airflow**
Discharge louvres are specially designed to stream air upwards along the ceiling for longer throws and delivering rapid cooling and even temperature distribution in the occupied space.
- Intelligent comfort**
Each model is fitted with Daikin's Intelligent Eye that automatically enables energy saving operations when the room is unoccupied for 20 minutes.

Note: Please see features checklist on page 33 for full list of features

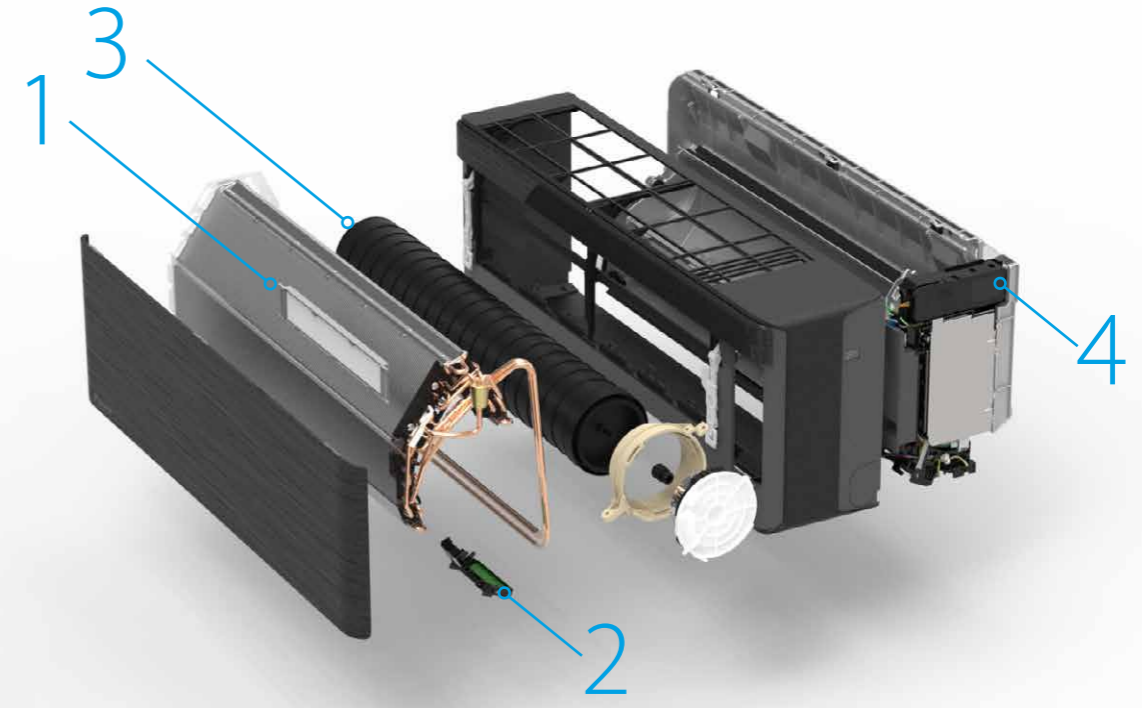

Mobile Controller Interface (Included)
Daikin's Mobile Controller Smartphone Interface allows you to control your Daikin Split System from anywhere, anytime.

Technology

- Advanced filter**
The titanium apatite deodorising air purification filter traps microscopic particles, decomposes odours and even deactivates bacteria.
- Grid eye sensor**
An additional built-in Grid Eye Sensor further monitors the floor temperature during heating and adjusts airflow direction to ensure even room temperature.
- Saw edge fan**
Our new 'Saw Edge' aerofoil blade design delivers greater volumes of air quietly whilst retaining Zena's compact form factor.
- Streamer Technology**
Discharges high speed electrons generating powerful oxidative decomposition that has been proven to eliminate more than 99.6%* of pollen in 2 hours, 99.9% of mould in 24 hours** and 99.61% of allergens in 24 hours*.



Energy rating

STAR RATING	CLASS	25	35	50	60
ZERL (Residential) Hot/Avg/Cold	COOL	4/3.5/3.5 ★	3.5/3.5/3.5 ★	3.5/3/3.5 ★	2.5/2.5/2.5 ★
	HEAT	3/3/2.5 ★	3/2.5/2 ★	3/2.5/2 ★	3/2.5/2 ★

ZERL (Residential) refers to 'Zoned Energy Rating Label' residential star rating as outlined in the GEMS 2019 Determination

*Verified at Wakayama Medical University with the following test condition: Irradiated allergens with Streamer & checked decomposition of allergen proteins by either the ELISA method, electrophoresis or electron microscopy.

**Verified at Japan Food Research Laboratories using antibacterial test/mould elimination test (test number: 204041635-001).

Alira X is a step ahead of the rest, delivering a perfect fusion of whisper quiet comfort, industry leading energy efficiency and indoor air quality technology.









2.2kW
- TO -
7.1kW
CAPACITY RANGE

7
MODELS

Alira X

A reflection of quality

- 
Perfect fusion
 New R32 Alira X is a perfect blend of progressive design aesthetic, superior energy performance & indoor air quality technology.
- 
Advanced purification
 Each model is fitted with three layers of filtration, prefilter for large particulates, enzyme blue deodorising filter for odours and Daikin's Streamer Technology for powerful oxidative decomposition of pollutants.
- 
Built-in Wi-Fi
 The Wireless LAN module for connection to Daikin's Mobile Controller smartphone interface is now conveniently included inside the casing of the indoor unit.
- 
Mould-proof operation
 Activates after cooling or dry operation to prevent the build up of mould and odour.*
- 
Intelligent comfort
 The 2-Area Intelligent Eye** is so clever it can now either direct airflow towards you or away from you for draught free comfort. If the room is unoccupied the unit will automatically enable energy saving operations.
- 
Coanda airflow
 Discharge louvres are specially designed to stream air upwards along the ceiling for longer throws and delivering rapid cooling and even temperature distribution in the occupied space.

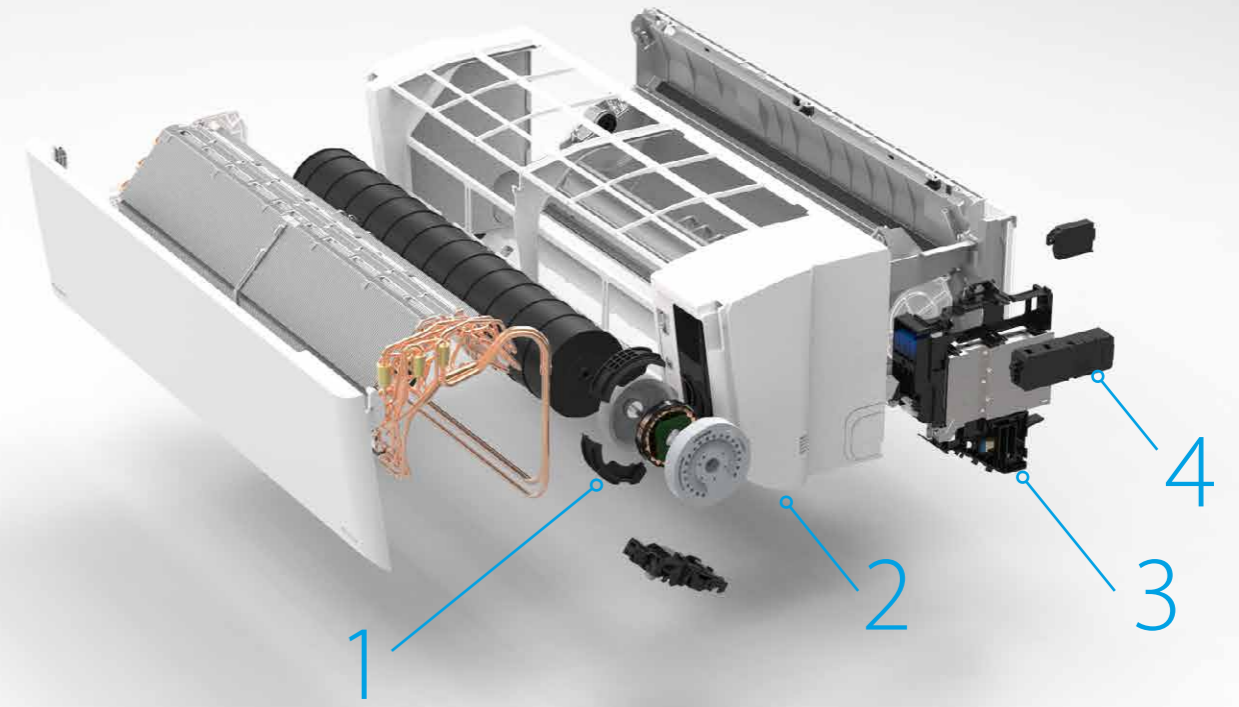

 **Mobile Controller Interface (Included)**
 Daikin's Mobile Controller Smartphone Interface allows you to control your Daikin Split System from anywhere, anytime.

Technology

- 1. Improved ODM motor**
 Improved compact 14 pole DC outer diameter rotor motor encased in rubber vibration dampeners delivers higher torque more efficiently than before while ensuring whisper quiet operations.
- 2. Redesigned dual louvres**
 Large dual louvres with aerodynamic end vanes help reduce turbulence for draught free comfort with longer throw distances of up to 10m (50-71 Class).
- 3. Humidity sensor**
 Monitors humidity to accurately control supply air temperature for comfortable and effective dehumidification of your room during Program Dry Function operation.
- 4. Streamer Technology**
 Discharges high speed electrons generating powerful oxidative decomposition that has been proven to eliminate more than 99.6%[^] of pollen in 2 hours, 99.9%^{^^} of mould in 24 hours and 99.61%[^] of allergens in 24 hours.



Energy rating

STAR RATING	CLASS	20	25	35	46	50	60	71
ZERL (Residential) Hot/Avg/Cold	COOL	6/5/5 ★	6/5.5/5.5 ★	5/4.5/5 ★	4.5/4/4 ★	5/4.5/5 ★	4.5/4.5/4.5 ★	3.5/3/3 ★
	HEAT	3.5/3.5/3 ★	4/3.5/3 ★	3.5/3.5/3 ★	4/3.5/3 ★	4/3.5/3 ★	4/3/2.5 ★	3.5/3/2.5 ★

ZERL (Residential) refers to 'Zoned Energy Rating Label' residential star rating as outlined in the GEMS 2019 Determination

[^]Verified at Wakayama Medical University with the following test condition: Irradiated allergens with Streamer & checked decomposition of allergen proteins by either the ELISA method, electrophoresis or electron microscopy.

^{^^}Verified at Japan Food Research Laboratories using antibacterial test/mould elimination test (test number: 204041635-001).

* Mould-proof operation function can be toggled (On/Off) via the wireless controller

**2-Area Intelligent Eye only applicable to 20-46 Class Models.

Note: Please see features checklist on page 33 for full list of features.

Delivered in understated confidence, featuring whisper quiet operation and premium comfort levels without compromising on style.



2.0kW
-TO-
7.1kW
CAPACITY RANGE

7
MODELS

REVERSE
CYCLE OR
COOLING
ONLY



Cora

Styled to perform

R32 refrigerant
R32 is the next generation in refrigerants with 66% lower 'Global Warming Potential Factor' than R410A, providing less risk of harm to the environment.

Inverter powerful operation
Push the POWERFUL button on the remote control and you'll be relieved with a cooling or heating boost for a 20 minute period, even if the unit's already operating at high capacity.

Precision control
For even greater precision and control, you can now set your room temperature in increments of 0.5°C to ensure optimal comfort conditions all year round.

Coanda airflow
Discharge louvres are specially designed to stream air upwards along the ceiling for longer throws and delivering rapid cooling and even temperature distribution in the occupied space.

Intelligent comfort
The 2-Area Intelligent Eye* is so clever it can now either direct airflow towards you or away from you for draught free comfort. If the room is unoccupied the unit will automatically enable energy saving operations.

Air purification
Each model is fitted with an enzyme blue deodorising air purification filter that traps microscopic particles, decomposes odours and even deactivates bacteria.

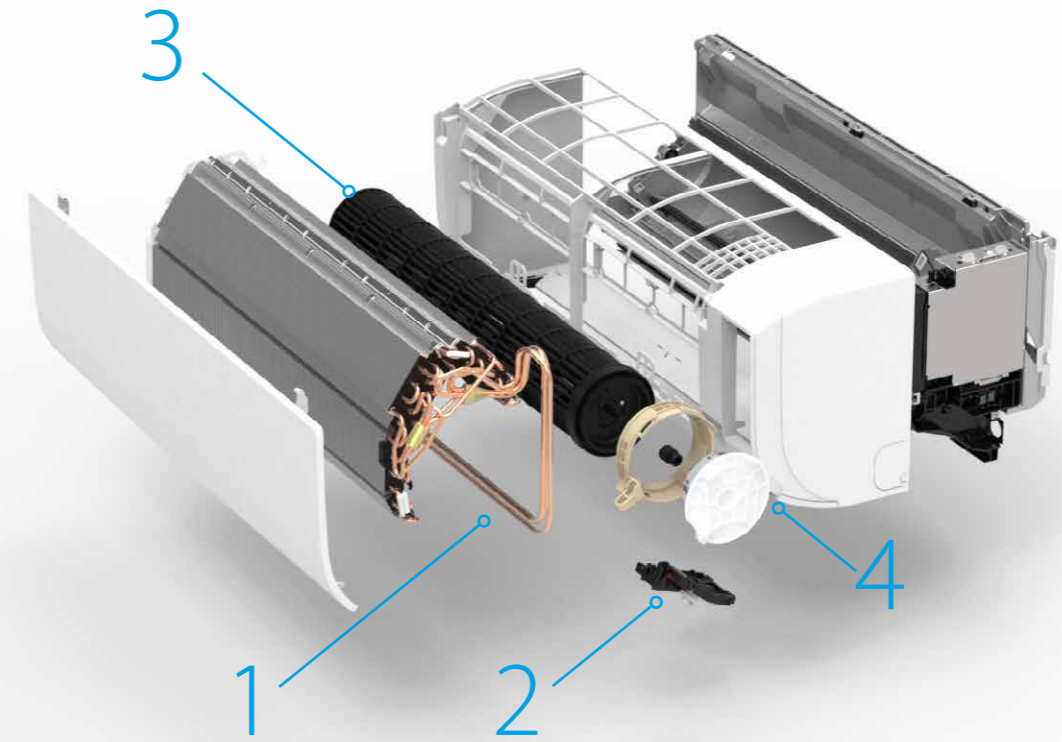

Mobile Controller Interface (Optional)
Daikin's Mobile Controller Smartphone Interface allows you to control your Daikin Split System from anywhere, anytime.

Technology

- 1. Redesigned heat exchanger**
Slit type fin design with Ø5mm piping increases heat exchange area for improved capacity output and energy performance.
- 2. 2-Area Intelligent Eye**
Gives you the option to direct airflow either towards or away from you for draught free comfort. If no occupation is detected, the air conditioner operates in energy saving mode.
- 3. Cross flow fan**
Large diameter rotor with aerofoil blade design delivers larger volumes of air more quietly than ever before.
- 4. New ODM motor**
Compact 10 pole DC outer diameter rotor motor delivers higher torque more efficiently.

Energy rating

STAR RATING	CLASS	20	25	35	46	50	60	71
ZERL (Residential) Hot/Avg/Cold	COOL	5/4.5/4.5 ★	6/5/5.5 ★	5/4.5/4.5 ★	4/3.5/4 ★	5/4.5/5 ★	4/4/4 ★	3.5/3/3 ★
	HEAT	3/3/2.5 ★	3.5/3/3 ★	3/2.5/2.5 ★	3/2.5/2.5 ★	3.5/3/2.5 ★	3.5/3/2.5 ★	3/2.5/2 ★

*2-Area Intelligent Eye only applicable to 20-46 Class Models.

Note: Please see features checklist on page 33 for full list of features.

ZERL (Residential) refers to 'Zoned Energy Rating Label' residential star rating as outlined in the GEMS 2019 Determination

Powerful performance and premium features meet sophisticated design to deliver ultimate comfort for open plan living.

XL PREMIUM



8.5kW
- & -
9.5kW
CAPACITY RANGE

2
MODELS

REVERSE
CYCLE OR
COOLING
ONLY

Combining high capacity performance with a sleek design to ensure comfort in open plan living environments.

XL



8.0kW
- & -
9.0kW
CAPACITY RANGE

2
MODELS

REVERSE
CYCLE

XL Premium

The ultimate choice for open plan living

- Advanced purification**
Each model is fitted with 3 layers of filtration, including a pre-filter, enzyme blue deodorising filter and Streamer Technology to catch and decompose odours and bacteria.
- Intelligent comfort**
Each model is fitted with Daikin's Intelligent Eye that automatically enables energy saving operations when the room is unoccupied for 20 minutes.
- Streamer Technology**
Daikin's signature Streamer Technology eliminates more than 99.6%¹ of pollen in 2 hours, 99.9%² of mould in 24 hours and 99.61%¹ of allergens in 24 hours.
- Built-in Wi-Fi control with voice assistant**
Connection to Daikin's Mobile Controller smartphone interface is now included, allowing voice control through connected Google and Amazon Assistant devices.
- Aerodynamic end vane louvres**
Redesigned main discharge louvres with aerodynamic end vanes reduces turbulence for better draught-free comfort.
- Mould-proof operation**
Activates after cooling or dry operation to prevent the build up of mould and odour.⁴

Energy rating

STAR RATING	CLASS	85	95
ZERL (Residential) Hot/Avg/Cold	COOL	3.5/3.0/3.5 ★	3.5/3.0/3.0 ★
	HEAT	2.5/2.0/2.0 ★	2.5/2.0/1.5 ★

¹Verified at Wakayama Medical University with the following test condition: Irradiated allergens with Streamer & checked decomposition of allergen proteins by either the ELISA method, electrophoresis or electron microscopy. ²Verified at Japan Food Research Laboratories using antibacterial test/mould elimination test (test number: 204041635-001). ³2-Area Intelligent Eye only applicable to 20-46 Class Models. ⁴Mould-proof operation function can be toggled (On/Off) via the wireless controller

Note: XL Premium & XL have different appearances, please see features checklist on page 33 for full list of features

XL

Designed for comfort in large spaces

- Air purification**
Each model is fitted with an enzyme blue deodorising air purification filter that traps microscopic particles, decomposes odours and even deactivates bacteria.
- Intelligent comfort**
Each model is fitted with Daikin's Intelligent Eye that automatically enables energy saving operations when the room is unoccupied for 20 minutes.
- Aerodynamic end vane louvres**
Redesigned main discharge louvres with aerodynamic end vanes reduces turbulence and for better draught free comfort.
- Comfort mode**
Airflow direction is optimised such that airflow is streamed upwards during cooling to prevent cold airflow being blown onto the body and downward during heating to drive warm air towards the floor of the room.
- Mould-proof operation**
Activates after cooling or dry operation to prevent the build up of mould and odour¹.

Energy rating

STAR RATING	CLASS	80	90
ZERL (Residential) Hot/Avg/Cold	COOL	3.5/3.0/3.5 ★	3.0/3.0/3.0 ★
	HEAT	2.5/2.0/1.5 ★	2.5/2.0/1.5 ★

¹Mould-proof operation can be toggled (On/Off) Via the wireless controller

Optional Wifi Adaptor BRP084C44 required for connection to Mobile Controller

ZERL (Residential) refers to 'Zoned Energy Rating Label' residential star rating as outlined in the GEMS 2019 Determination

Compact floor standing unit with a wide selection of capacities, ideal for placement under a window sill or semi-recessed into an unused fireplace.



2.5kW
- TO -
7.1kW
CAPACITY RANGE



6
MODELS



Floor Standing

Compact & convenient

- 
Dual discharge vents
 You can select to use either top, or top and bottom discharge vents to distribute air evenly through the room for better heating comfort.
- 
Econo mode
 This mode limits the maximum power consumed by the system preventing the tripping of your circuit breaker should you have other household appliances operating simultaneously with your air conditioner.
- 
Wide operating range
 Daikin's floor standing units are robust in design and feature an intelligent defrost system. So even when the mercury drops as low as -15°C, your home still stays comfortable in winter.

- 
Standby power function
 When the system is not in use, power supply to the outdoor unit is turned off and the indoor unit switches to standby mode.
- 
Hot start
 Prior to heating, the indoor unit warms to a pre-set temperature before the fan switches on, ensuring only warm air is discharged and eliminating cold draughts.
- 
Air purification
 Each model is fitted with a titanium apatite deodorising air purification filter that traps microscopic particles, decomposes odours and even deactivates bacteria.

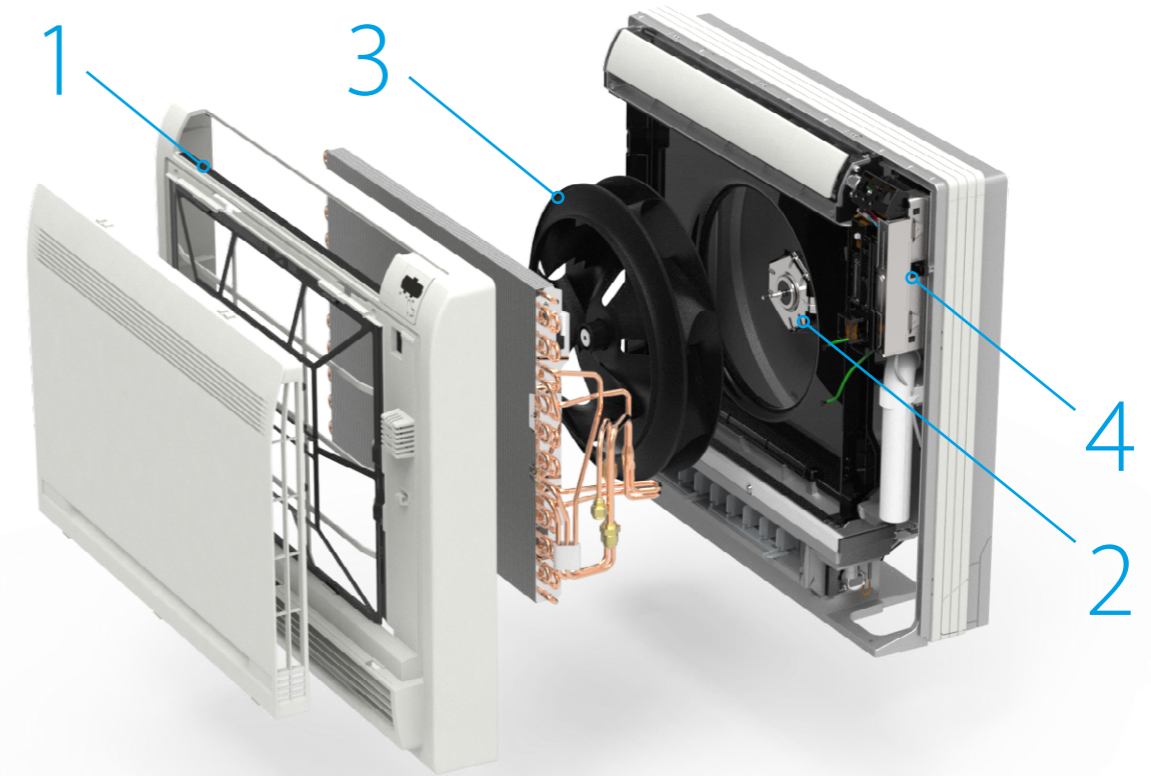

Technology

- 1. Advanced filtration**
 Features the combination of a particulate prefilter for collecting dust particles and a titanium apatite deodorising air purification filter.
- 2. Turbo fan**
 The large swept blades enable air to be discharged quietly and efficiently via both the top and bottom discharge vents for even airflow into the room.
- 3. DC fan motor**
 Daikin's DC Fan motor is efficient and compact, featuring five step fan speeds including quiet and auto mode.
- 4. Program dry function**
 When operating in this mode, the microprocessor intelligently adjusts temperature and airflow rate to reduce humidity with minimal compromise to comfort.

Energy rating

STAR RATING	CLASS	25	35	45	50	60	71
ZERL (Residential) Hot/Avg/Cold	COOL	3.5/3/3 ★	3.5/3/3 ★	2.5/2.5/2.5 ★	3.5/3.5/3.5 ★	3/2.5/3 ★	3/2.5/3 ★
	HEAT	3.5/3/2.5 ★	3/2.5/2 ★	3/2.5/2 ★	3.5/2.5/2 ★	2.5/2/1.5 ★	2/2/1.5 ★



Mobile Controller

Wi-Fi control for your Daikin wall mounted split

Mobile Controller puts your air conditioner's frequently used functions at your fingertips with an easy to use app.

In conjunction with Daikin's BRP072C42/BRP084C44 wireless LAN adaptor*, the easy to use Mobile Controller app lets you use your smartphone or tablet^ to operate your Daikin wall mounted air conditioning unit via Wi-Fi or the internet.

when you arrive home. With no subscription costs from Daikin, all you need is a permanent internet connection for your Wi-Fi network, and an internet connection for your phone or tablet.

The Daikin Mobile Controller app is available for download, free from the Apple App Store or Google Play.

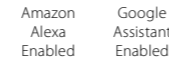

Three ways to connect

1. Direct connection

For locations without a Wi-Fi network, the app can wirelessly connect directly to the a wireless LAN adaptor equipped air conditioner, when in range.

2. Wi-Fi connection

A LAN equipped air conditioner can easily be joined to a local Wi-Fi network. Once connected, the system can be controlled from any networked Android or iOS device.

3. Internet connection

Monitor and control your system from virtually anywhere, adjusting temperature and setting for a comfortable environment ready for

FUNCTION	ZENA	ALIRA X	CORA	XL PREMIUM	XL
Start/stop operation	✓	✓	✓	✓	✓
Set operation mode:	✓	✓	✓	✓	✓
Auto/Cool/Heat/Fan/Dry	✓	✓	✓	✓	✓
Set temperature operation	✓	✓	✓	✓	✓
Set fan speed	✓	✓	✓	✓	✓
Set airflow direction	✓	✓	✓		
Show room temperature	✓	✓	✓	✓	✓
Group control	✓	✓	✓	✓	✓
Error notification	✓	✓	✓	✓	✓
Set weekly schedule: - Start/stop operation - Select operation mode - Set temperature Maximum 6 actions per day	✓	✓	✓	✓	✓
Vacation mode	✓	✓	✓	✓	✓

*BRP072C42 includes Modbus protocol, Remote Control PCB (BRP067A42 or BRP980B42) also required for some models, see features checklist on page 33 for details

^Portrait orientation only

The Sensitive Choice for your home



We're proud of our innovations. So we're pleased to announce that Daikin is the only Split System to receive approval from the National Asthma Council Australia. They introduced the Sensitive Choice® program to help identify products better suited for people who suffer from asthma and allergies. Daikin Split Systems and Air Purifiers are recognised by the Sensitive Choice® program, and carry the Blue Butterfly symbol.

Daikin cares for your air
All Daikin Split Systems and Air Purifiers are designed with an air-purifying filter. Many are fitted with a more advanced Titanium Apatite or Enzyme Blue Deodorising Air Purification Filter. These filters not only trap most microscopic airborne particles, but also assist to decompose odours, absorb and deactivate bacteria. Music to the ears of every sensitive nose.



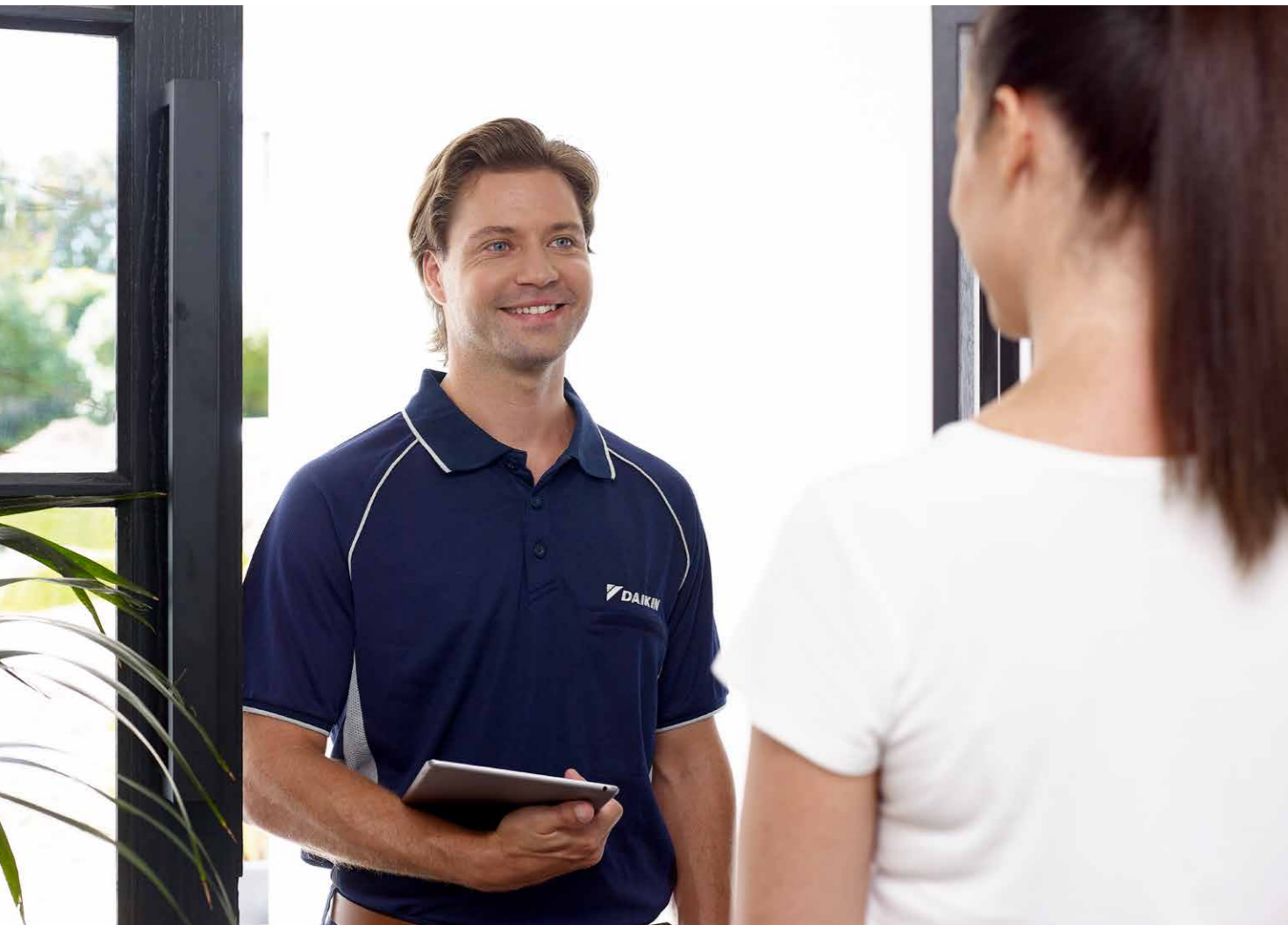

Why Choose a Daikin Specialist Dealer?

Like us, our Dealers are specialists. They know the ups and downs, ins and outs of air conditioning. So their expertise ensures you get the right advice for your needs.

Daikin Specialist Dealers provide custom designed solutions for your home through an in-home quotation. Dealers will not only supply and install the best possible air conditioning solution but will also provide ongoing maintenance to ensure peak efficient performance over the life of the system.

To take the stress out of air conditioning your home, speak to a Daikin Specialist Dealer. With over 450 Specialist Dealers across Australia, our specialists are ready to help you fit the right air conditioning solution for your home.

All appointed Daikin Specialist Dealers are independently owned and operated businesses.

WHITE HAIR LINE



BLACK WOOD

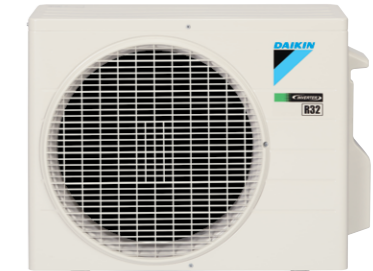

INDOOR UNIT		FTXJ25T2VMAW	FTXJ35T2VMAW	FTXJ50T2VMAW	FTXJ60T2VMAW	FTXJ25T2VMAK	FTXJ35T2VMAK	FTXJ50T2VMAK	FTXJ60T2VMAK
OUTDOOR UNIT		RXJ25T2VMA	RXJ35T2VMA	RXJ50T2VMA	RXJ60T2VMA	RXJ25T2VMA	RXJ35T2VMA	RXJ50T2VMA	RXJ60T2VMA
Rated Capacity	Cool (kW)	2.5	3.5	5.0	6.0	2.5	3.5	5.0	6.0
	Heat (kW)	3.2	3.7	6.0	7.2	3.2	3.7	6.0	7.2
Capacity Range	Cool (kW)	0.9-3.7	0.9-4.2	1.1-5.6	1.1-6.5	0.9-3.7	0.9-4.2	1.1-5.6	1.1-6.5
	Heat (kW)	0.9-5.0	0.9-5.2	1.0-7.9	1.0-8.2	0.9-5.0	0.9-5.2	1.0-7.9	1.0-8.2
Indoor Airflow Rate (H)	Cool (l/s)	177	190	218	243	177	190	218	243
	Heat (l/s)	203	212	238	273	203	212	238	273
Indoor Fan Speeds		5 steps, quiet and automatic							
Star Rating (Hot/Avg/Cold) ZERL (Residential)	Cool	4/3.5/3.5	3.5/3.5/3.5	3.5/3/3.5	2.5/2.5/2.5	4/3.5/3.5	3.5/3.5/3.5	3.5/3/3.5	2.5/2.5/2.5
	Heat	3/3/2.5	3/2.5/2.5	3/2.5/2	3/2.5/2	3/3/2.5	3/2.5/2.5	3/2.5/2	3/2.5/2
Front Panel Colour		White Hair Line				Black Wood			
Power Supply		1 phase, 220-240V, 50Hz							
Power Input (Rated)	Cool (kW)	0.49	0.81	1.32	1.83	0.49	0.81	1.32	1.83
	Heat (kW)	0.66	0.81	1.49	1.88	0.66	0.81	1.49	1.88
E.E.R/C.O.P	Cool/Heat	5.10/4.85	4.32/4.57	3.79/4.03	3.28/3.83	5.10/4.85	4.32/4.57	3.79/4.03	3.28/3.83
T.C.S.P.F (Residential)	Hot/Avg/Cold	5.91/5.43/5.47	5.50/5.13/5.27	5.09/4.81/5.00	4.43/4.22/4.40	5.91/5.43/5.47	5.50/5.13/5.27	5.07/4.73/4.90	4.43/4.17/4.34
H.S.P.F (Residential)	Hot/Avg/Cold	4.93/4.70/4.40	4.62/4.41/4.07	4.67/4.29/3.95	4.53/4.14/3.78	4.93/4.70/4.40	4.62/4.41/4.07	4.67/4.29/3.95	4.53/4.14/3.78
A.E.E.R/A.C.O.P	Cool/Heat	5.03/4.80	4.29/4.53	3.77/4.01	3.27/3.82	5.03/4.80	4.29/4.53	3.77/4.01	3.27/3.82
Dimensions (HxWxD)	Indoor (mm)	295x798x185				295x798x185			
	Outdoor (mm)	550x675x284		695x930x350		550x675x284		695x930x350	
Weight	Indoor (kg)	11	11	11	11	11	11	11	11
	Outdoor (kg)	30	30	54	54	30	30	54	54
Compressor Type		Hermetically Sealed Swing Type							
Refrigerant Type		R32							
Max Pipe Length	(m)	20	20	30	30	20	20	30	30
Max Level Difference	(m)	15	15	20	20	15	15	20	20
Pipe Sizes	Liquid (mm)	6.4	6.4	6.4	6.4	6.4	6.4	6.4	6.4
	Gas (mm)	9.5	9.5	12.7	12.7	9.5	9.5	12.7	12.7
Outdoor Operating Range	Cool (°CDB)	-10 to 46							
	Heat (°CWB)	-15 to 18							
Indoor Sound Level (H/SL)	Cool (dBA)	40/19	42/20	45/32	48/33	40/19	42/20	45/32	48/33
	Heat (dBA)	41/19	42/20	45/32	48/33	41/19	42/20	45/32	48/33
Outdoor Sound Level (H/SL)	Cool (dBA)	47/43	49/44	47/44	49/45	47/43	49/44	47/44	49/45
	Heat (dBA)	48/44	49/45	48/45	52/45	48/44	49/45	48/45	52/45
Outdoor EPA Sound Power Level (H)	Cool (dBA)	59	61	59	61	59	61	59	61
	Heat (dBA)	60	61	60	64	60	61	60	64



ZERL (Residential) refers to 'Zoned Energy Rating Label' residential star rating as outlined in the GEMS 2019 Determination. Please refer to notes on page 33.

Alira X – Reverse Cycle



INDOOR UNIT		FTXM20YVMA	FTXM25YVMA	FTXM35YVMA	FTXM46W2VMA	FTXM50W2VMA	FTXM60W2VMA	FTXM71W2VMA	
OUTDOOR UNIT		RXM20YVMA	RXM25YVMA	RXM35YVMA	RXM46W2VMA	RXM50W2VMA	RXM60W2VMA	RXM71W2VMA	
Rated Capacity	Cool (kW)	2.2	2.5	3.5	4.6	5.0	6.0	7.1	
	Heat (kW)	2.7	3.2	3.7	4.7	6.0	7.2	8.0	
Capacity Range	Cool (kW)	1.0-2.8	1.0-3.7	1.0-4.2	0.9-5.5	1.1-6.7	1.1-7.5	2.0-8.9	
	Heat (kW)	1.0-4.4	1.0-5.4	1.0-5.5	1.0-6.7	1.0-8.0	1.0-9.8	2.0-10.8	
Indoor Airflow Rate (H)	Cool (l/s)	203	215	225	253	342	395	410	
	Heat (l/s)	198	213	225	250	342	395	410	
Indoor Fan Speeds	5 steps, quiet and automatic								
Star Rating (Hot/Avg/Cold) ZERL (Residential)	Cool	6/5/5	6/5.5/5.5	5/4.5/5	4.5/4/4	5/4.5/5	4.5/4.5/4.5	3.5/3/3	
	Heat	3.5/3.5/3	4/3.5/3	3.5/3.5/3	4/3.5/3	4/3.5/3	4/3/2.5	3.5/3/2.5	
Front Panel Colour	White								
Power Supply	1 phase, 220-240V, 50Hz								
Power Input (Rated)	Cool (kW)	0.42	0.47	0.80	1.17	1.13	1.48	2.00	
	Heat (kW)	0.50	0.64	0.76	1.04	1.23	1.61	1.96	
E.E.R./C.O.P	Cool/Heat	5.29/5.40	5.38/5.00	4.38/4.89	3.95/4.52	4.42/4.88	4.05/4.47	3.55/4.08	
TCSPF (Residential)	Hot/Avg/Cold	7.80/6.85/6.99	7.99/7.13/7.28	6.96/6.48/6.77	6.05/5.61/5.92	6.96/6.44/6.82	6.46/6.02/6.43	5.46/4.76/4.92	
HSPF (Residential)	Hot/Avg/Cold	5.34/5.13/4.76	5.50/5.12/4.71	5.44/5.02/4.50	5.61/5.03/4.52	5.84/5.25/4.60	5.50/4.90/4.26	5.10/4.54/4.00	
A.E.E.R./A.C.O.P	Cool/Heat	5.20/5.33	5.30/4.95	4.34/4.84	3.93/4.49	4.40/4.85	4.04/4.45	3.48/4.00	
Dimensions (HxWxD)	Indoor (mm)	299x838x275			299x920x275	299x1100x275			
	Outdoor (mm)	550x675x284			695x930x350				
Weight	Indoor (kg)	12	12	12	13	15	15	15	
	Outdoor (kg)	28	30	30	51	54	54	60	
Compressor Type	Hermetically Sealed Swing Type								
Refrigerant Type	R32								
Max Pipe Length	(m)	20	20	20	30	30	30	30	
Max Level Difference	(m)	15	15	15	20	20	20	20	
Pipe Sizes	Liquid (mm)	6.4	6.4	6.4	6.4	6.4	6.4	6.4	
	Gas (mm)	9.5	9.5	9.5	12.7	12.7	12.7	15.9	
Outdoor Operating Range	Cool (°CDB)	-10 to 46							
	Heat (°CWB)	-15 to 18							
Indoor Sound Level (H/SL)	Cool (dBA)	39/19	41/19	42/19	43/26	45/28	48/29	49/30	
	Heat (dBA)	39/20	40/20	42/20	43/26	45/28	48/29	49/30	
Outdoor Sound Level (H/SL)	Cool (dBA)	46/43	47/43	49/44	47/44	47/44	49/45	53/49	
	Heat (dBA)	47/44	48/44	49/45	48/45	48/45	52/45	54/49	
Outdoor EPA Sound Power Level (H)	Cool (dBA)	58	59	61	59	59	61	65	
	Heat (dBA)	59	60	61	60	60	64	66	

ZERL (Residential) refers to 'Zoned Energy Rating Label' residential star rating as outlined in the GEMS 2019 Determination Please refer to notes on page 33

Alira X – Cooling Only



INDOOR UNIT		FTKM20YVMA	FTKM25YVMA	FTKM35YVMA	FTKM46W2VMA	FTKM50W2VMA	FTKM60W2VMA	FTKM71W2VMA	
OUTDOOR UNIT		RKM20YVMA	RKM25YVMA	RKM35YVMA	RKM46W2VMA	RKM50W2VMA	RKM60W2VMA	RKM71W2VMA	
Rated Capacity	Cool (kW)	2.2	2.5	3.5	4.6	5.0	6.0	7.1	
	Capacity Range	Cool (kW)	1.0-2.8	1.0-3.7	1.0-4.2	0.9-5.5	1.1-6.7	1.1-7.5	2.0-8.9
Indoor Airflow Rate (H)	Cool (l/s)	203	215	225	253	342	395	410	
Indoor Fan Speeds	5 steps, quiet and automatic								
Star Rating (Hot/Avg/Cold) ZERL (Residential)	Cool	6/5/5	6/5.5/5.5	5/4.5/5	4.5/4/4	5/4.5/5	4.5/4.5/4.5	3.5/3/3	
Front Panel Colour	White								
Power Supply	1 phase, 220-240V, 50Hz								
Power Input (Rated)	Cool (kW)	0.42	0.47	0.80	1.17	1.13	1.48	2.00	
E.E.R	Cool	5.29	5.38	4.38	3.95	4.42	4.05	3.55	
TCSPF (Residential)	Hot/Avg/Cold	7.80/6.85/6.99	7.99/7.13/7.28	6.96/6.48/6.77	6.05/5.61/5.92	6.96/6.44/6.82	6.46/6.02/6.43	5.46/4.76/4.92	
A.E.E.R	Cool	5.20	5.30	4.34	3.93	4.40	4.04	3.48	
Dimensions (HxWxD)	Indoor (mm)	299x838x275			299x920x275	299x1100x275			
	Outdoor (mm)	550x675x284			695x930x350				
Weight	Indoor (kg)	12	12	12	13	15	15	15	
	Outdoor (kg)	28	30	30	51	54	54	60	
Compressor Type	Hermetically Sealed Swing Type								
Refrigerant Type	R32								
Max Pipe Length	(m)	20	20	20	30	30	30	30	
Max Level Difference	(m)	15	15	15	20	20	20	20	
Pipe Sizes	Liquid (mm)	6.4	6.4	6.4	6.4	6.4	6.4	6.4	
	Gas (mm)	9.5	9.5	9.5	12.7	12.7	12.7	15.9	
Outdoor Operating Range	Cool (°CDB)	-10 to 46							
Indoor Sound Level (H/SL)	Cool (dBA)	39/19	41/19	42/19	43/26	45/28	48/29	49/30	
Outdoor Sound Level (H/SL)	Cool (dBA)	46/43	47/43	49/44	47/44	47/44	49/45	53/49	
Outdoor EPA Sound Power Level (H)	Cool (dBA)	58	59	61	59	59	61	65	

ZERL (Residential) refers to 'Zoned Energy Rating Label' residential star rating as outlined in the GEMS 2019 Determination Please refer to notes on page 33

Cora – Reverse Cycle



INDOOR UNIT		FTXV20W2VMA	FTXV25W2VMA	FTXV35W2VMA	FTXV46W2VMA	FTXV50W2VMA	FTXV60W2VMA	FTXV71W2VMA
OUTDOOR UNIT		RXV20W2VMA	RXV25W2VMA	RXV35W2VMA	RXV46W2VMA	RXV50W2VMA	RXV60W2VMA	RXV71W2VMA
Rated Capacity	Cool (kW)	2.0	2.5	3.5	4.6	5.0	6.0	7.1
	Heat (kW)	2.7	3.2	3.7	4.7	6.0	7.2	8.0
Capacity Range	Cool (kW)	0.9-2.8	0.9-3.7	0.9-4.2	0.9-5.5	1.1-6.7	1.1-7.5	2.0-8.9
	Heat (kW)	0.9-4.4	0.9-5.4	0.9-5.5	1.0-6.7	1.0-8.0	1.0-9.8	2.0-10.8
Indoor Airflow Rate (H)	Cool (l/s)	152	173	175	203	267	310	310
	Heat (l/s)	157	168	183	202	287	333	328
Indoor Fan Speeds		5 steps, quiet and automatic						
Star Rating (Hot/Avg/Cold) ZERL (Residential)	Cool	5/4.5/4.5	6/5/5.5	5/4.5/4.5	4/3.5/4	5/4.5/5	4/4/4	3.5/3/3
	Heat	3/3/2.5	3.5/3/3	3/2.5/2.5	3/2.5/2.5	3.5/3/2.5	3.5/3/2.5	3/2.5/2
Front Panel Colour		White						
Power Supply		1 phase, 220-240V, 50Hz						
Power Input (Rated)	Cool (kW)	0.40	0.49	0.81	1.20	1.14	1.52	1.93
	Heat (kW)	0.53	0.64	0.77	1.11	1.30	1.63	1.88
E.E.R/C.O.P	Cool/Heat	5.00/5.09	5.10/5.00	4.32/4.81	3.83/4.23	4.39/4.62	3.95/4.42	3.68/4.26
TCSPF (Residential)	Hot/Avg/Cold	6.95/6.13/6.23	7.69/6.85/7.02	6.64/6.20/6.42	5.67/5.28/5.54	6.88/6.35/6.72	5.91/5.56/5.89	5.38/4.80/4.96
HSPF (Residential)	Hot/Avg/Cold	4.65/4.57/4.34	5.10/4.86/4.53	4.63/4.47/4.13	4.81/4.43/4.04	5.12/4.72/4.19	5.00/4.57/4.02	4.78/4.39/3.91
A.E.E.R/A.C.O.P	Cool/Heat	4.90/5.02	5.02/4.94	4.28/4.76	3.81/4.20	4.36/4.59	3.93/4.40	3.62/4.19
Dimensions (HxWxD)	Indoor (mm)	285x770x223			295x990x263			
	Outdoor (mm)	550x675x284			695x930x350			
Weight	Indoor (kg)	9	9	9	9	13	13	13
	Outdoor (kg)	28	30	30	51	54	54	60
Compressor Type		Hermetically Sealed Swing Type						
Refrigerant Type		R32						
Max Pipe Length	(m)	20	20	20	30	30	30	30
Max Level Difference	(m)	15	15	15	20	20	20	20
Pipe Sizes	Liquid (mm)	6.4	6.4	6.4	6.4	6.4	6.4	6.4
	Gas (mm)	9.5	9.5	9.5	12.7	12.7	12.7	15.9
Outdoor Operating Range	Cool (°CDB)	-10 to 46						
	Heat (°CWB)	-15 to 18						
Indoor Sound Level (H/SL)	Cool (dBA)	38/19	42/19	42/19	44/26	45/28	48/29	49/30
	Heat (dBA)	39/20	40/20	42/20	43/26	45/28	48/29	49/30
Outdoor Sound Level (H/SL)	Cool (dBA)	46/43	47/43	49/44	47/44	47/44	49/45	53/49
	Heat (dBA)	47/44	48/44	49/45	48/45	48/45	52/45	54/49
Outdoor EPA Sound Power Level (H)	Cool (dBA)	58	59	61	59	59	61	65
	Heat (dBA)	59	60	61	60	60	64	66

ZERL (Residential) refers to 'Zoned Energy Rating Label' residential star rating as outlined in the GEMS 2019 Determination Please refer to notes on page 33

Cora – Cooling Only



INDOOR UNIT		FTKM20Q2VMA	FTKM25Q2VMA	FTKM35Q2VMA	FTKM46Q2VMA	FTKM50Q2VMA	FTKM60Q2VMA	FTKM71Q2VMA
OUTDOOR UNIT		RKM20Q2VMA	RKM25Q2VMA	RKM35Q2VMA	RKM46Q2VMA	RKM50Q2VMA	RKM60Q2VMA	RKM71Q2VMA
Rated Capacity	Cool (kW)	2.0	2.5	3.5	4.6	5.0	6.0	7.1
	Capacity Range	Cool (kW)	0.9-2.8	0.9-3.7	0.9-4.2	0.9-5.5	1.1-6.7	1.1-7.5
Indoor Airflow Rate (H)	Cool (l/s)	152	167	175	203	267	310	310
Indoor Fan Speeds		5 steps, quiet and automatic						
Star Rating (Hot/Avg/Cold) ZERL (Residential)	Cool	5/4.5/4.5	6/5/5.5	5/4.5/4.5	4/3.5/4	5/4.5/5	4/4/4	3.5/3/3
Front Panel Colour		White						
Power Supply		1 phase, 220-240V, 50Hz						
Power Input (Rated)	Cool (kW)	0.40	0.49	0.81	1.20	1.14	1.52	1.93
E.E.R	Cool	5.00	5.10	4.32	3.83	4.39	3.95	3.68
TCSPF (Residential)	Hot/Avg/Cold	6.95/6.13/6.23	7.69/6.85/7.02	6.64/6.20/6.42	5.67/5.28/5.54	6.88/6.35/6.72	5.91/5.56/5.89	5.38/4.80/4.96
A.E.E.R	Cool	4.91	5.02	4.28	3.81	4.36	3.93	3.62
Dimensions (HxWxD)	Indoor (mm)	285x770x223			295x990x263			
	Outdoor (mm)	550x675x284			695x930x350			
Weight	Indoor (kg)	9	9	9	9	13	13	13
	Outdoor (kg)	28	30	30	51	54	54	60
Compressor Type		Hermetically Sealed Swing Type						
Refrigerant Type		R32						
Max Pipe Length	(m)	20	20	20	30	30	30	30
Max Level Difference	(m)	15	15	15	20	20	20	20
Pipe Sizes	Liquid (mm)	6.4	6.4	6.4	6.4	6.4	6.4	6.4
	Gas (mm)	9.5	9.5	9.5	12.7	12.7	12.7	15.9
Outdoor Operating Range	Cool (°CDB)	-10 to 46						
Indoor Sound Level (H/SL)	Cool (dBA)	38/19	40/19	42/19	44/26	45/28	48/29	49/30
Outdoor Sound Level (H/SL)	Cool (dBA)	46/43	47/43	49/44	47/44	47/44	49/45	53/49
Outdoor EPA Sound Power Level (H)	Cool (dBA)	58	59	61	59	59	61	65

ZERL (Residential) refers to 'Zoned Energy Rating Label' residential star rating as outlined in the GEMS 2019 Determination Please refer to notes on page 33

XL Premium - Reverse Cycle and Cooling Only



INDOOR UNIT		REVERSE CYCLE		COOLING ONLY	
		FTXM85WVMA	FTXM95WVMA	FTKM85WVMA	FTKM95WVMA
OUTDOOR UNIT		RXM85WVMA	RXM95WVMA	RKM85WVMA	RKM95WVMA
Rated Capacity	Cool (kW)	8.5	9.5	8.5	9.5
	Heat (kW)	9.0	10.3	-	-
Capacity Range	Cool (kW)	2.0-10.5	2.0-11.2	2.0-10.5	2.0-11.2
	Heat (kW)	1.9-11.6	1.9-12.0	-	-
Indoor Airflow Rate (H)	Cool (l/s)	380	410	380	410
	Heat (l/s)	403	425	-	-
Indoor Fan Speeds		5 steps, quiet and automatic			
Star Rating (Hot/Avg/Cold) ZERL (Residential)	Cool	3.5/3.0/3.5	3.5/3.0/3.0	3.5/3.0/3.5	3.5/3.0/3.0
	Heat	2.5/2.0/2.0	2.5/2.0/1.5	-	-
Front Panel Colour		White			
Power Supply		1 phase, 220-240V, 50Hz			
Power Input (Rated)	Cool (kW)	2.35	2.80	2.35	2.80
	Heat (kW)	2.66	3.10	-	-
E.E.R./C.O.P	Cool/Heat	3.62/3.38	3.39/3.32	3.62	3.39
TCSPF (Residential)	Hot/Avg/Cold	5.28/4.91/5.15	5.01/4.69/4.94	5.28/4.91/5.15	5.01/4.69/4.94
HSPF (Residential)	Hot/Avg/Cold	4.47/3.93/3.50	4.26/3.74/3.24	-	-
A.E.E.R./A.C.O.P	Cool/Heat	3.59/3.36	3.37/3.31	3.59 / -	3.37 / -
Dimensions (HxWxD)	Indoor (mm)	329x1240x278		329x1240x278	
	Outdoor (mm)	990x940x320		990x940x320	
Weight	Indoor (kg)	19	19	19	19
	Outdoor (kg)	77	77	77	77
Compressor Type		Hermetically Sealed Swing Type			
Refrigerant Type		R32			
Max Pipe Length	(m)	30	30	30	30
Max Level Difference	(m)	20	20	20	20
Pipe Sizes	Liquid (mm)	6.4	6.4	6.4	6.4
	Gas (mm)	15.9	15.9	15.9	15.9
Outdoor Operating Range	Cool (°CDB)	-10 to 46			
	Heat (°CWB)	-15 to 18		-	-
Indoor Sound Level (H/SL)	Cool (dBA)	49/35	51/36	49/35	51/36
	Heat (dBA)	49/33	51/33	-	-
Outdoor Sound Level (H/SL)	Cool (dBA)	54/51	54/51	54/51	54/51
	Heat (dBA)	55/51	55/51	-	-
Outdoor EPA Sound Power Level (H)	Cool (dBA)	66	66	66	66
	Heat (dBA)	67	67	-	-

XL - Reverse Cycle



INDOOR UNIT		FTXV80WVMA	FTXV90WVMA
OUTDOOR UNIT		RXV80WVMA	RXV90WVMA
Rated Capacity	Cool (kW)	8.0	9.0
	Heat (kW)	9.0	10.3
Capacity Range	Cool (kW)	2.0-10.5	2.0-11.2
	Heat (kW)	1.9-11.6	1.9-12.0
Indoor Airflow Rate (H)	Cool (l/s)	410	440
	Heat (l/s)	403	425
Indoor Fan Speeds		5 steps, quiet and automatic	
Star Rating (Hot/Avg/Cold) ZERL (Residential)	Cool	3.5/3.0/3.5	3.0/3.0/3.0
	Heat	2.5/2.0/1.5	2.5/2.0/1.5
Front Panel Colour		Ivory White	
Power Supply		1 phase, 220-240V, 50Hz	
Power Input (Rated)	Cool (kW)	2.17	2.65
	Heat (kW)	2.75	3.15
E.E.R./C.O.P	Cool/Heat	3.69/3.27	3.40/3.27
TCSPF (Residential)	Hot/Avg/Cold	5.26/4.90/5.12	4.99/4.66/4.90
HSPF (Residential)	Hot/Avg/Cold	4.29/3.79/3.40	4.10/3.61/3.15
A.E.E.R./A.C.O.P	Cool/Heat	3.66/3.25	3.38/3.25
Dimensions (HxWxD)	Indoor (mm)	329x1240x278	
	Outdoor (mm)	990x940x320	
Weight	Indoor (kg)	19	19
	Outdoor (kg)	77	77
Compressor Type		Hermetically Sealed Swing Type	
Refrigerant Type		R32	
Max Pipe Length	(m)	30	30
Max Level Difference	(m)	20	20
Pipe Sizes	Liquid (mm)	6.4	6.4
	Gas (mm)	15.9	15.9
Outdoor Operating Range	Cool (°CDB)	-10 to 46	
	Heat (°CWB)	-15 to 18	
Indoor Sound Level (H/SL)	Cool (dBA)	51/37	53/38
	Heat (dBA)	51/35	52/35
Outdoor Sound Level (H/SL)	Cool (dBA)	54/51	54/51
	Heat (dBA)	55/51	55/51
Outdoor EPA Sound Power Level (H)	Cool (dBA)	66	66
	Heat (dBA)	67	67

Floor Standing – Reverse Cycle



INDOOR UNIT		FVXS25R2V1A	FVXS35R2V1A	FVXS45R2V1A	FVXS50R2V1A	FVXS60L2VMA	FVXS71L2VMA
OUTDOOR UNIT		RXS25R2V1A	RXS35R2V1A	RXS45R2V1A	RXS50R2V1A	RXS60L2VMA	RXS71L2VMA
Rated Capacity	Cool (kW)	2.46	3.5	4.5	5.0	6.0	7.1
	Heat (kW)	2.9	4.52	5.56	5.8	7.0	7.65
Capacity Range	Cool (kW)	1.3-3.0	1.7-3.8	1.7-5.0	1.7-5.6	2.3-6.7	3.0-8.5
	Heat (kW)	1.3-4.5	1.7-5.0	1.7-8.1	1.7-8.1	2.3-9.0	3.0-10.0
Indoor Airflow Rate (H)	Cool (l/s)	137	147	178	260	292	273
	Heat (l/s)	170	170	218	327	285	317
Indoor Fan Speeds		5 steps, quiet and automatic					
Star Rating (Hot/Avg/Cold) ZERL (Residential)	Cool	3.5/3/3	3.5/3/3	2.5/2.5/2.5	3.5/3.5/3.5	3/2.5/3	3/2.5/3
	Heat	3.5/3/2.5	3/2.5/2	3/2.5/2	3.5/2.5/2	2.5/2/1.5	2/2/1.5
Front Panel Colour		White					
Power Supply		1 phase, 220-240V, 50Hz					
Power Input (Rated)	Cool (kW)	0.59	0.91	1.35	1.29	1.70	2.13
	Heat (kW)	0.63	1.16	1.45	1.44	2.03	2.21
E.E.R./C.O.P	Cool/Heat	4.17/4.60	3.85/3.90	3.33/3.83	3.88/4.03	3.53/3.45	3.33/3.46
TCSPF (Residential)	Hot/Avg/Cold	5.25/4.78/4.86	5.04/4.66/4.79	4.50/4.21/4.36	5.49/5.13/5.37	4.71/4.44/4.61	4.62/4.38/4.58
HSPF (Residential)	Hot/Avg/Cold	5.14/4.76/4.37	4.61/4.20/3.81	4.68/4.16/3.62	5.02/4.49/4.00	4.02/3.66/3.26	3.81/3.53/3.21
A.E.E.R./A.C.O.P	Cool/Heat	4.11/4.54	3.81/3.86	3.31/3.81	3.85/4.00	3.51/3.43	3.32/3.45
Dimensions (HxWxD)	Indoor (mm)	600x700x210			770x850x290		
	Outdoor (mm)	550x765x285	735x825x300			770x900x320	990x940x320
Weight	Indoor (kg)	14	14	14	25	25	25
	Outdoor (kg)	34	46	46	46	71	80
Compressor Type		Hermetically sealed swing type					
Refrigerant Type		R410A					
Max Pipe Length (m)		20	30	30	30	30	30
Max Level Difference (m)		15	20	20	20	20	20
Pipe Sizes	Liquid (mm)	6.4	6.4	6.4	6.4	6.4	9.5
	Gas (mm)	9.5	12.7	12.7	12.7	12.7	15.9
Outdoor Operating Range	Cool (°CDB)	10 to 46					
	Heat (°CWB)	-15 to 18					
Indoor Sound Level (H/SL)	Cool (dBA)	38/23	39/24	44/32	45/32	47/33	46/33
	Heat (dBA)	41/23	41/24	48/32	49/32	45/33	47/34
Outdoor Sound Level (H/SL)	Cool (dBA)	46/43	47/44	47/44	47/44	49/46	52/49
	Heat (dBA)	50/44	50/45	51/45	51/45	49/46	54/50
Outdoor EPA Sound Power Level (H)	Cool (dBA)	58	59	59	59	63	66
	Heat (dBA)	62	62	63	63	63	66

ZERL (Residential) refers to 'Zoned Energy Rating Label' residential star rating as outlined in the GEMS 2019 Determination. Please refer to notes on page 33

Features Checklist

SERIES	ZENA	ALIRA X		CORA		XL PREMIUM		XL	FLOOR STANDING
TYPE	Reverse Cycle	Reverse Cycle	Cooling Only	Reverse Cycle	Cooling Only	Reverse Cycle	Cooling Only	Reverse Cycle	Reverse Cycle
DC Inverter	✓	✓	✓	✓	✓	✓	✓	✓	✓
PAM Control	✓	✓	✓	✓	✓	✓	✓	✓	✓
Standby Power Function	✓	✓	✓	✓	✓	✓	✓	✓	✓
Power-Airflow Dual Flaps	✓	✓	✓	✓ ²	✓ ²	✓	✓	✓	
Vertical Auto-Swing (up and down)	✓	✓	✓	✓	✓	✓	✓	✓	✓
Horizontal Auto-Swing (right and left)	✓	✓	✓	✓	✓	✓	✓	✓	
3-D Airflow	✓	✓	✓	✓	✓	✓	✓	✓	
Vertical Airflow	✓								
Comfort Airflow Mode	✓	✓	✓	✓	✓	✓	✓	✓	
Indoor Unit Quiet Operation	✓	✓	✓	✓	✓	✓	✓	✓	✓
Outdoor Unit Quiet Operation	✓	✓	✓	✓	✓	✓	✓	✓	✓
Intelligent Eye	✓	✓ ²	✓ ²	✓ ²	✓ ²	✓	✓	✓	
2-Area Intelligent Eye		✓ ¹	✓ ¹	✓ ¹	✓ ¹				
Grid Eye Sensor	✓								
Automatic Operation	✓	✓	✓	✓	✓	✓	✓	✓	✓
Program Dry Function	✓			✓	✓				✓
Improved Program Dry Function		✓	✓			✓	✓	✓	
Auto Fan Speed	✓	✓	✓	✓	✓	✓	✓	✓	✓
Hot Start	✓	✓		✓		✓	✓	✓	✓
Titanium Apatite Deodorising Filter	✓								✓
Enzyme Blue Deodorising Filter		✓	✓	✓	✓	✓	✓	✓	
Air-Purifying Filter	✓	✓	✓	✓	✓	✓	✓	✓	✓
Streamer Technology	✓	✓	✓			✓	✓		
Mould Proof Operaton		✓	✓			✓	✓	✓	
Econo Mode	✓	✓	✓	✓	✓	✓	✓	✓	✓
Powerful Operation	✓	✓	✓	✓	✓	✓	✓	✓	✓
LCD Wireless Remote Control	✓	✓	✓	✓	✓	✓	✓	✓	✓
Indoor Unit On/Off Switch	✓	✓	✓	✓	✓	✓	✓	✓	✓
24-Hour On/Off Timer	✓	✓	✓	✓	✓	✓	✓	✓	✓
Weekly Timer	✓	✓	✓	✓	✓	✓	✓	✓	✓
Night Set Mode	✓	✓	✓	✓	✓	✓	✓	✓	✓
Auto-Restart after Power Failure	✓	✓	✓	✓	✓	✓	✓	✓	✓
Self Diagnosis with Digital Display	✓	✓	✓	✓	✓	✓	✓	✓	✓
Anticorrosion Treatment of Outdoor Heat Exchanger Fin	✓	✓	✓	✓	✓	✓	✓	✓	✓
Demand Enabled Response (DRED)	✓	✓	✓	✓	✓	✓	✓	✓	✓
Wireless LAN Connection	✓	✓	✓	✓ ³	✓ ³	✓	✓	✓ ⁴	
0.5°C Step Room Temperature Control	✓	✓	✓	✓	✓	✓	✓	✓	

Notes:

- 1 Only available for 2.0-4.6 kW Class
- 2 Only available for 5.0-7.1 kW Class
- 3 Optional Accessory, Remote Control PCB also required (BRP067A42 for 20-46 Class, BRP980B42 for 50-71 Class).
- 4 Optional Accessory
- i. The Rated Capacity, Power Input and Running Current are determined under conditions T1 (cooling) or H1 (heating) of AS/NZS 3823.1.1
Cooling: Indoor temp: 27°CDB/19°CWB
Outdoor temp: 35°CDB/24°CWB
Heating: Indoor temp: 20°CDB/15°CWB
Outdoor temp: 7°CDB/6°CWB
- ii. The cooling (or heating) output capacity will be reduced below the rated value as the outdoor temperature approaches the maximum (or minimum) outdoor temperature operating range limit.
- iii. Indoor and outdoor unit sound levels are determined in an anechoic chamber at a distance of 1 metre from the front of the unit. They are normally higher during actual operation due to ambient conditions.
- iv. Inverter air conditioners do not have a current surge during start up. The compressor start current of an inverter air conditioner is typically lower than specified running current.
- v. The specifications, designs and information in this brochure are subject to change without notice. Unit colours shown are as close as possible to actual unit colours. Colours depicted in this brochure may vary slightly.

Notes

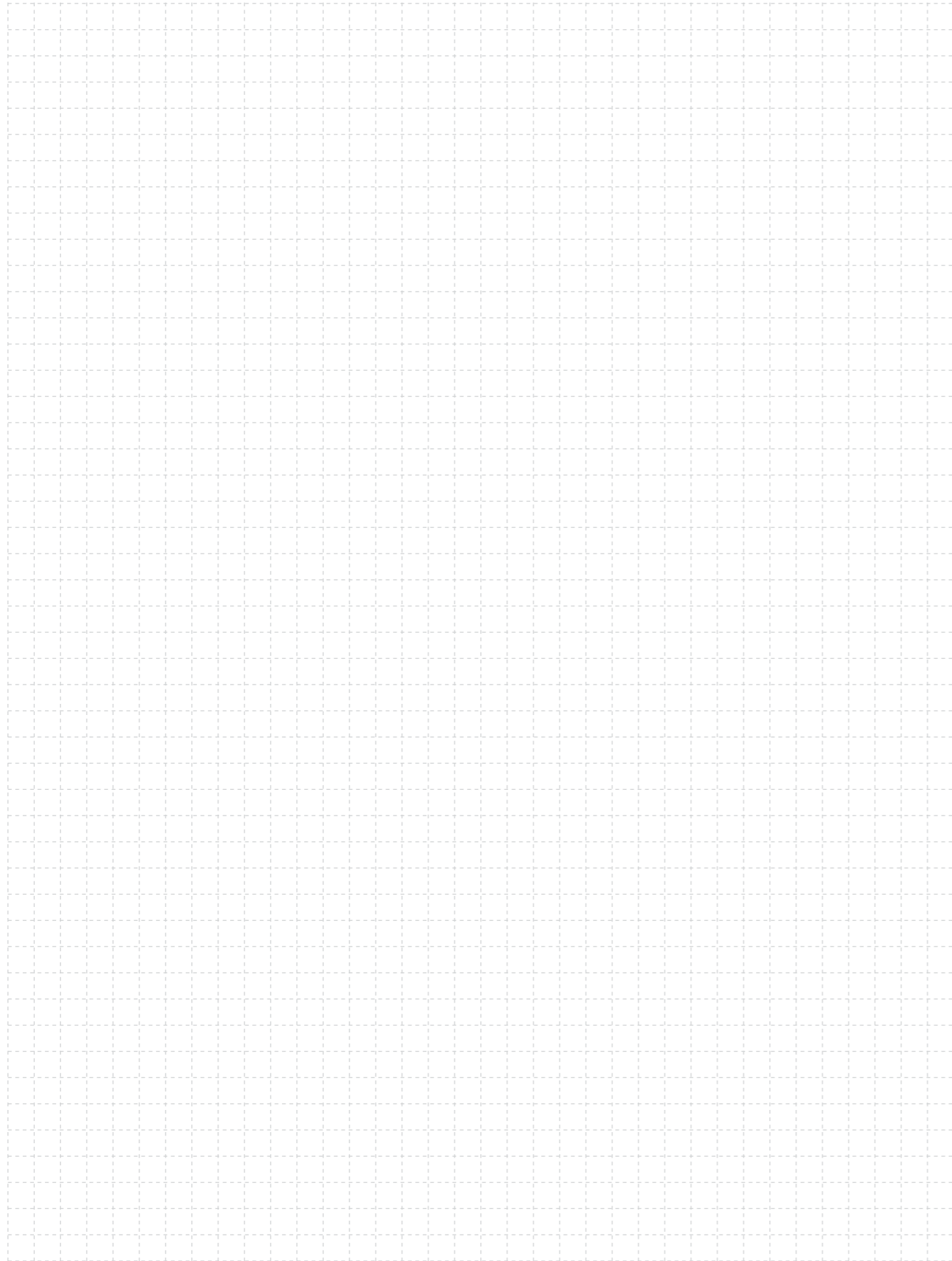

© Copyright in the contents of this brochure is owned by Daikin Australia Pty Limited and no part of the document may be reproduced in any form without the express written permission of Daikin Australia Pty Limited.

ASSUMPTIONS

All representations made in Daikin marketing and promotional material are based on the assumptions that the correct equipment has been selected, appropriately sized and installed in accordance with Daikin's installation instructions and standard industry practices.

QUALITY CERTIFICATIONS

Daikin Industries Limited was the first air conditioning equipment manufacturer in Japan to receive ISO 9001 certification. All Daikin manufacturing facilities have been certified to ISO 9001 Quality Management System requirements. ISO 9001 is a certificate for quality assurance concerning 'design, development, manufacturing, installation and related service' of products manufactured at that factory.

Residential Air Conditioning

Manufacturing Div (ISO 9001)
JQA-0486 May 2, 1994
(Shiga Plant)

Commercial Air Conditioning and Refrigeration

Manufacturing Div (ISO 9001)
JMI0107 December 28, 1992
(Kanaoka Factory and Rinkai Factory at Sakai Plant)

ENVIRONMENTAL CERTIFICATIONS

Daikin Industries Limited has received ISO 14001 Environmental Certification for the Daikin production facilities listed below. ISO 14001 is an international standard specifying requirement for an environmental management system, enabling an organisation to formulate policy and objectives, taking into account legislative requirements and information about significant environmental impacts. It applies to those environmental aspects within the organisation's control and over which it can be expected to have an influence.

The certification relates only to the environmental management system and does not constitute any endorsement of the products shipped from the facility by the International Organisation for Standardisation.

Head Office / Tokyo Office	Certificate number: EC02J0355
Shiga Plant (Japan)	Certificate number: EC99J2044
Sakai Plant (Japan)	Certificate number: JQA-E-80009
Daikin Industries Ltd (Thailand)	Certificate number: JQA-E-90108
Yodogawa Plant (Japan)	Certificate number: EC99J2057
Daikin Australia Pty. Ltd.	Certificate number: CEM20437

Daikin Australia Pty Limited (ISO 9001)

QEC 23256
May 12, 2006
Sydney, Brisbane, Adelaide, Melbourne, Newcastle, Townsville, Perth



Daikin Australia Pty Limited (ISO 45001)

OHS 20939 17
February 2021
Sydney



Daikin Australia Pty Limited (ISO 14001)

CEM 20437
October 27, 2006
Sydney, Brisbane, Adelaide, Melbourne, Perth



Industrial System and Chiller Products Manufacturing Div (ISO 9001)

JQA-0495 May 16, 1994
(Yodogawa Plant and Kanaoka Factory and Kishiwada Factory)

Daikin Europe N.V (ISO 9001)

Lloyd 928589.1 June 2, 1993

Daikin Industries (Thailand) Ltd

JQA-1452 September 13, 2002
(ISO 9001)



GLOW CITY

352 Morphett Road
Warradale SA 5046
8397 6100

GLOW SOUTH COAST

16 Wright Road
Goolwa SA 5214
8554 2860

info@glowhce.com.au | glowhce.com.au



Daikin Australia Pty Limited ABN 62 000 172 967

For all Sales enquiries, email: sales@daikin.com.au

For Customer Service or Technical Support, call: 1300 368 300

Scan to learn more about Daikin Split Systems

